

INSTALLATION

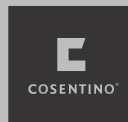

INSTALLATION GUIDELINES.

How to fix the Silestone undermounted sink to the countertop using the fixing kit

Please pay special attention to the following guidelines.

The steps described are vital in the correct installation of the Silestone sink into the countertop.

Cosentino S.A. is not responsible for any errors resulting from not following the guidelines provided.

Cosentino S.A. recommends this procedure for the following reasons:
It is a very straightforward installation and does not require special tools.

- If for any reason you would like to change an installed Silestone sink, there will be no need to change the countertop since the sink can be easily removed without damage.
- Cosentino S.A. cannot be liable for shade variations between the sink and countertop when they have been manufactured separately.

BEFORE INSTALLATION

1. MAKING THE SINK CUT-OUT IN THE COUNTERTOP

The cut-out made in the countertop should be 2mm. smaller all round than the inner size of the sink. For CNC operation the hole must be made in accordance with the template included in the sink packaging.

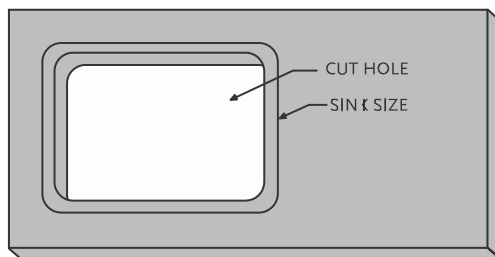

2. POLISHING THE SINK CUT-OUT

Cleaning the interior of the countertop with a hand radial drilling machine is ideal to enable the operator to check for any flaws which may hinder any direct contact between the countertop and the sink.

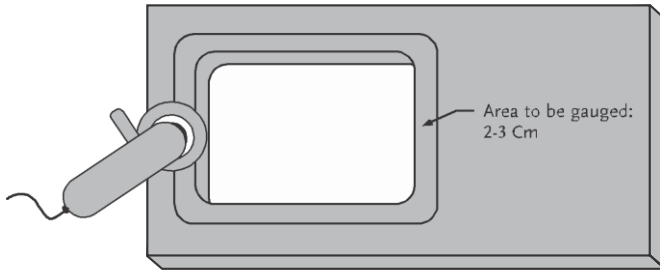

A bevel of 2-3mm. must be made in the underside of the countertop to serve as a bonding line with the sink and make the joint appear less noticeable.

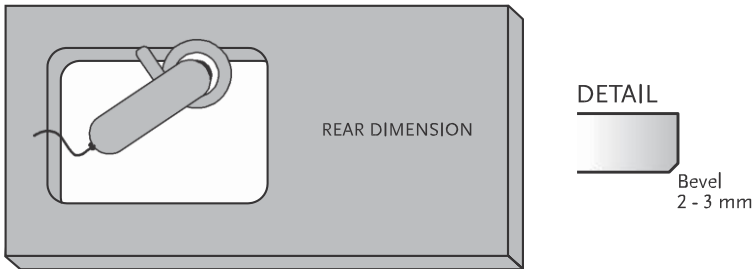

HOME INSTALLATION

3. CLEANING THE PARTS TO BE BONDED

The two parts which are to be bonded (worktop and the sink) should be thoroughly cleaned with solvents or alcohol before applying the silicone; otherwise the silicone will not bond correctly and the countertop and sink will not be sealed properly. Make sure that the silicone is colour coordinated where possible..

INSTALLATION

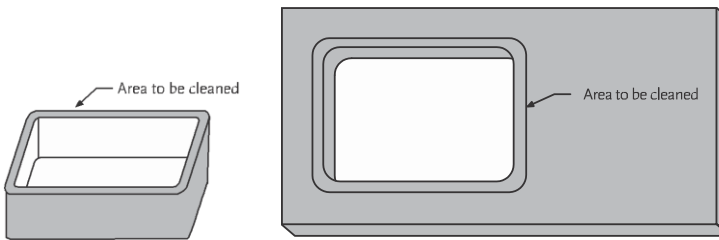

4. INSTALLING THE ANCHORAGE KIT

Is mandatory to install the sink with protection bars. Those bars could be purchase in Cosentino. We show two different kind of bars typically used for this propose.

- A Clamping profile system.

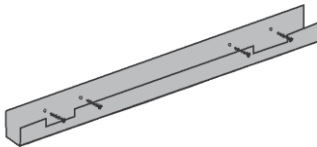

- Telescopic clamping bars

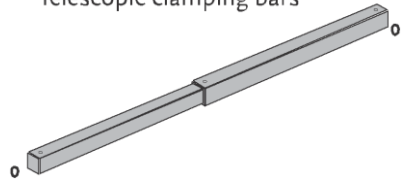

- Fitting the clamping profile system:

This system will be fastened by screws placed both sides of the kitchen cupboard interior (one on each side), and will be fixed at a distance of 21 cm below the worktop to allow a correct installation.

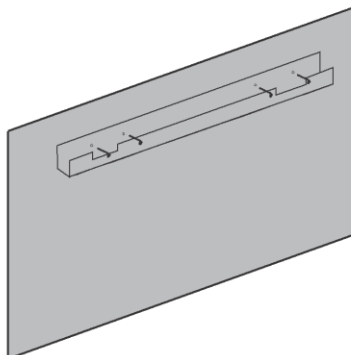



- Telescopic clamping bars

Minimum dimension of 80cm. to a maximum dimension of 120cm according to the size of the kitchen base unit. They should be placed crosswise by locating the heads on the clamping profile anchorage and then levelled to be perfectly aligned and to evenly support the entire sink.

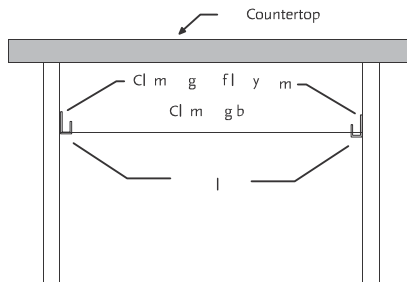

5. APPLYING SILICONE ONTO THE SINK

Apply the silicone onto the sink edge. You must use the correct colour COLORSIL silicone to bond the sink and countertop (COLORSIL is provided together with the sink)

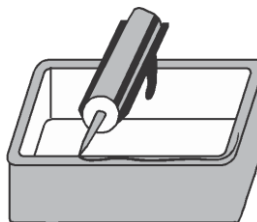

INSTALLATION



6. FITTING THE SINK TO THE UNDERSIDE OF THE COUNTERTOP

Once the silicone has been applied, the sink should be offered up to the countertop by using the anchorage system and adjusting the support bolts. Level the sink to ensure a good silicone bond between the countertop and the sink is achieved.

Care must be taken to ensure a perfect bond and not to over-tighten the bolts.

Clean off any excess silicone before it dries. Cosentino recommends using CLEANCOLORSIL. Do not use any products containing METHYLNE CHLORIDE

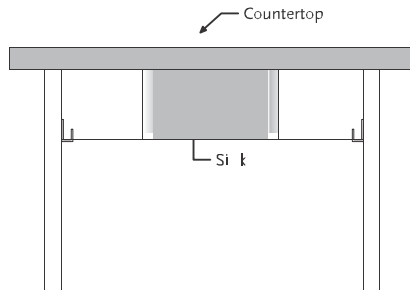



APPENDIX

INSTALLATION GUIDE OF SILESTONE BUILT- IN SINK

Specific and adequate tools are required for this type of installation



If you don't have the suitable tools or the expertise needed to install this type of installation, Cosentino do not recommend you to do it. In this case use the previous option.

1. MAKING THE COUNTERTOP CUT-OUT

The countertop cut-out should be 3mm. smaller than the sink's inner size although this will depend on the technician's criteria since the smaller the flange is, a lesser amount of finishing will be required.

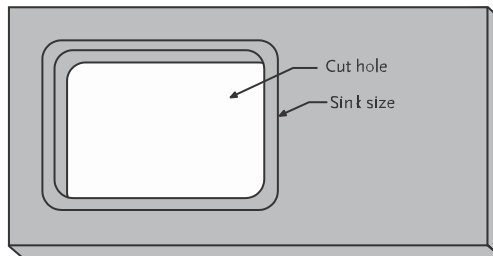

2. REBATING SURFACE

A rebate of 23mm. width around the cut-out to allow 5mm of material thickness must be made. This process will be by CNC application.

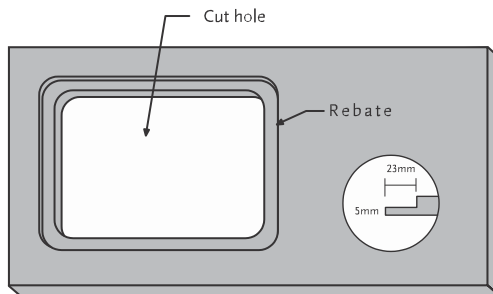



3. CLEANING PARTS TO BE BONDED

The two parts which are to be bonded (worktop and the sink) should be thoroughly cleaned with solvents or alcohol before applying the silicone; otherwise the silicone will not bond correctly and the countertop and sink will not be sealed properly. Make sure that the silicone is colour coordinated where possible.

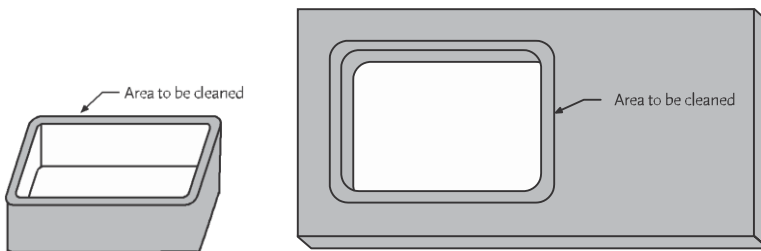

4. USING SOLUMASTIC

The Solumastic must be applied to entire edge

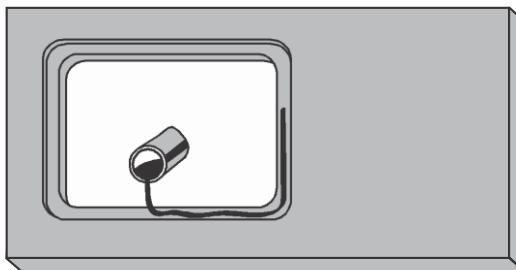



5. TIGHTENING SINK INTO COUNTERTOP

Once the resin has been applied, clamps and jacks must be used to secure the sink into the countertop until it absorbs as much resin as possible. The non-absorbed resin will turn into a noticeable joint. This adhesive system is quite similar to a 2+2 procedure or if we make edge mitres the intention should be to hide the joint between the two pieces.

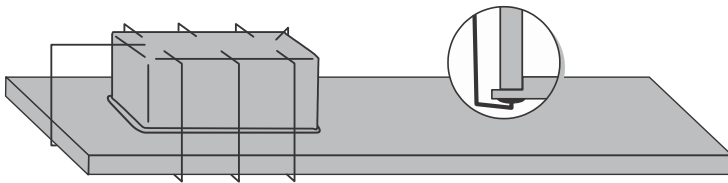

6. CLEANING BONDED PARTS

Clean with alcohol or solvents to 10cm. around all of the areas to be bonded

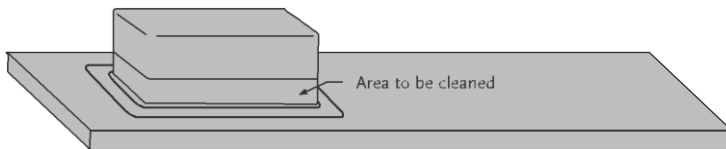

7. FILLING IN THE GAP BETWEEN THE SINK AND COUNTERTOP

The gap between the sink and countertop must be filled in with resin; otherwise the countertop could be damaged. It is also advisable to glue small pieces of Silestone to the countertop and sink so as to strengthen their bond. It is important to make sure that the sink waste and overflow components are not obstructed by the sink installation kit or reinforcement pieces when installing.

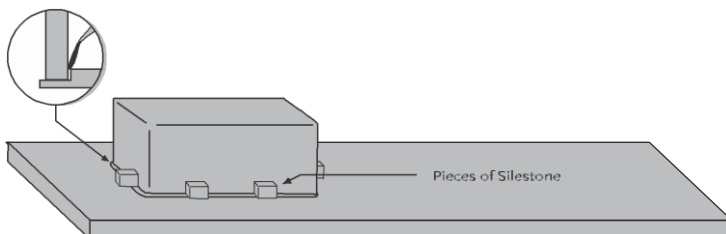

8. REINFORCING THE COUNTERTOP

In order to reinforce the sink and countertop structure, it is advisable to fix strips onto the underside of the countertop covering the processed area to the full width of the kitchen base unit.

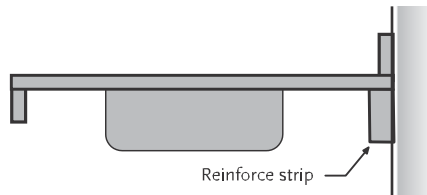

9. CUTTING THE BEVEL

Once the sink is fastened to the countertop, it is advisable to polish the inner edges and create a bevel to allow a neat joint between the countertop and the sink.

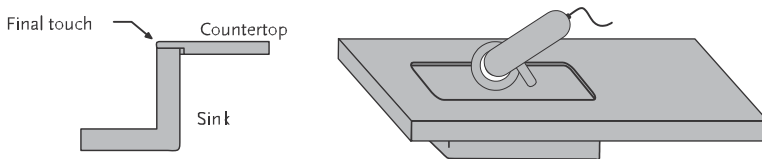

Declaration of conformity to the European Union directives:

Cosentino S.A, in A-334 road, km 59 (04850) Cantoria Almería, declare under exclusive responsibility the conformity of the product:

Type : Silestone Sink

Name: ONE

Use: Domestic use

To which this declaration is referred, with the norms or another normative documents:

UNE-EN 13310: Kitchen sinks. Functional requirements and test methods.

And that it is conform with COUNCIL DIRECTIVE of 21 December 1988 on the approximation of the laws of the Member States relating to materials and articles intended to come into contact with foodstuffs (89/109/EEC).

